



Living Top 15kg

Slides for suspended panels
Sistemi di scorrimento per ante sospese



Living Top 15/kg

Adjustable sliding system for suspended panels with damped and standard stops.

Sistema di scorrevoli regolabili per ante sospese con fermi ammortizzati e standard.



The ideal solution that grants the highest aesthetic results

Living Top is an adjustable system with upper sliding, designed for wooden doors weighing up to 15 kg and with soft-closing option.

The system represents the best solution to realize applications with clean and linear aesthetic, thanks to flat-bottom with no lower profiles needed.

Living Top is extremely easy to install, thanks to sliding trolleys automatic fastening system.

Living Top is the ideal solution from Terno Scorrevoli dedicated to living spaces, offices and contract.

La soluzione ideale che garantisce un alto livello estetico

Living Top è un sistema regolabile a scorrimento superiore per ante in legno fino a 15 kg con fermi ammortizzati.

Il sistema rappresenta la soluzione ottimale per ottenere un'estetica pulita e lineare, grazie all'assenza di profili inferiori.

Living Top è estremamente semplice da installare, grazie ai sistemi automatici di aggancio degli scorrevoli.

Living Top è la soluzione ideale di Terno Scorrevoli per la zona giorno, l'ufficio o il settore contract.



Living Top 15 kg



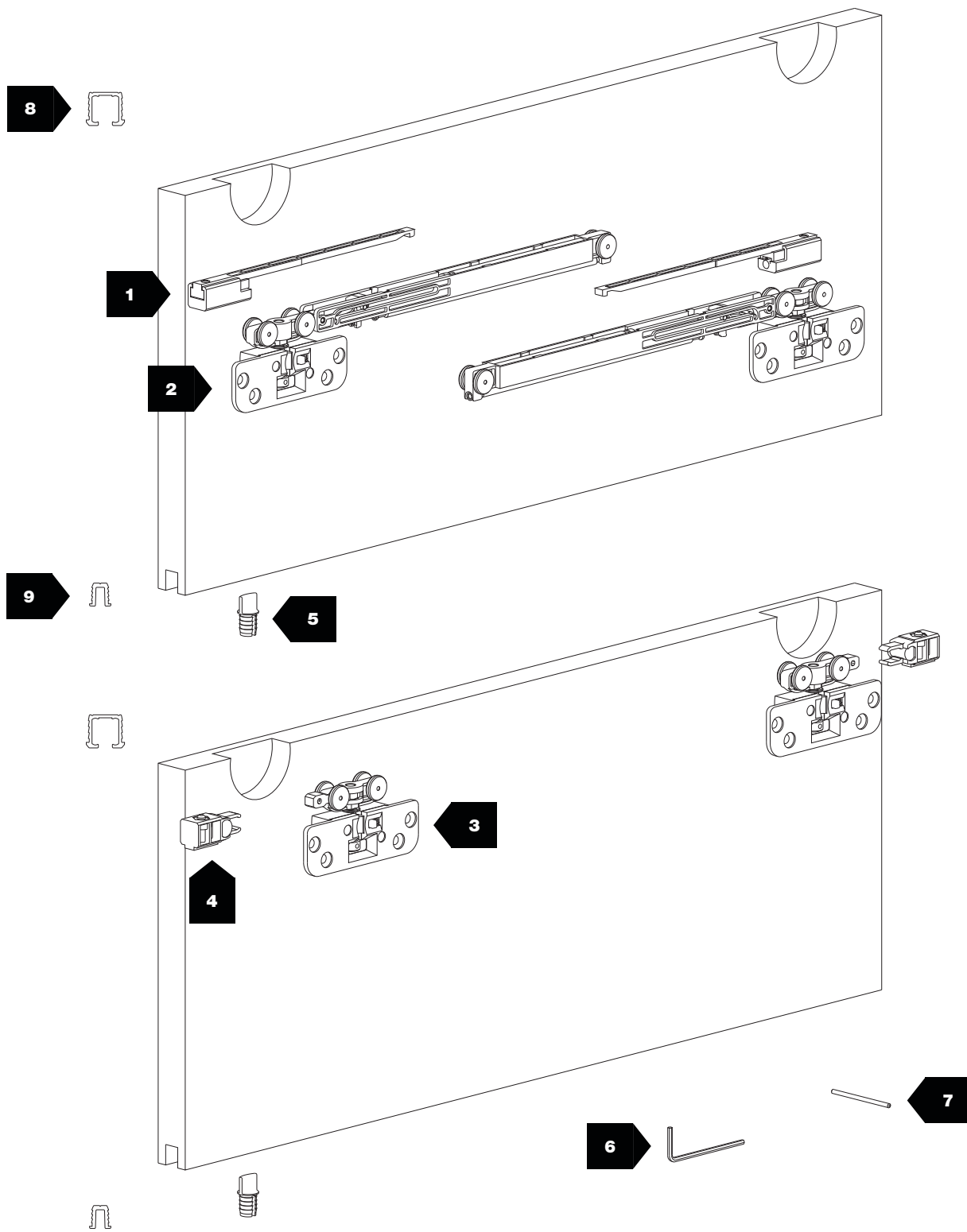



Slides for suspended panels
Sistemi di scorrimento per ante sospese



Min. 400 mm

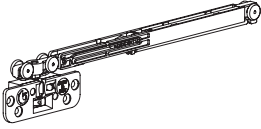

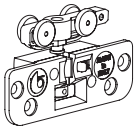
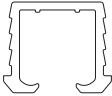
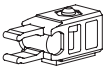
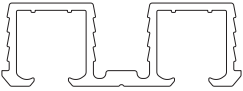
15 kg

N°	Barcode	Image	kg		N°	Barcode	Image	kg	
1	2166/03		15		6	409		15	
2	2174		15		7	973		15	
3	2173		15		8	2175 8 00 0.02175 8 01 0.02175		15	
4	2162		15			2172 8 00 0.02172 8 01 0.02172		15	OPTIONAL +
5	2168		15		9	2170 8 00 0.02170 8 01 0.02170		15	

Living Top 15 kg

Slides for suspended panels
Sistemi di scorrimento per ante sospese



Kit for N.1 door
Kit per N.1 anta



N.2 Soft damper stoppers
N.2 Fermi ammortizzati

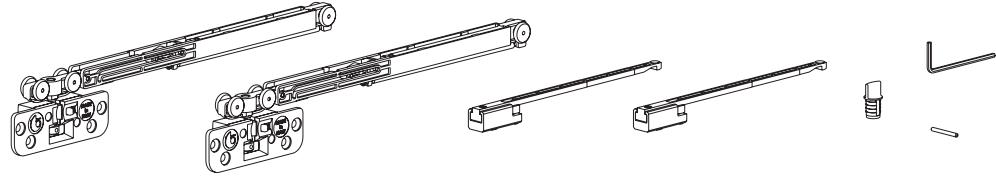

OLD CODE	NEW CODE	Weight	Quantity
2174/A/2	K.1251.2	15 kg	10x



Kit for N.1 door
Kit per N.1 anta



N.1 Soft damper stoppers
N.1 Fermi ammortizzati



N.1 Standard stoppers
N.1 Fermi standard

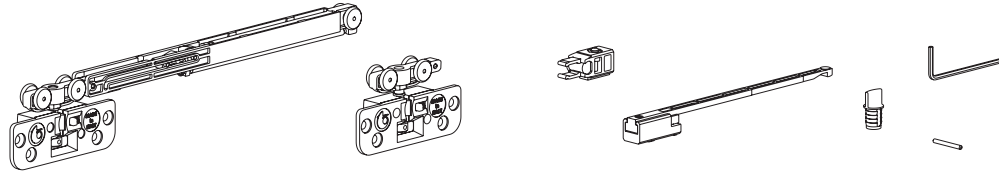

OLD CODE	NEW CODE	Weight	Quantity
2174/A/1	K.1251.3	15 kg	10x



Kit for N.1 door
Kit per N.1 anta



N.2 Standard stoppers
N.2 Fermi standard

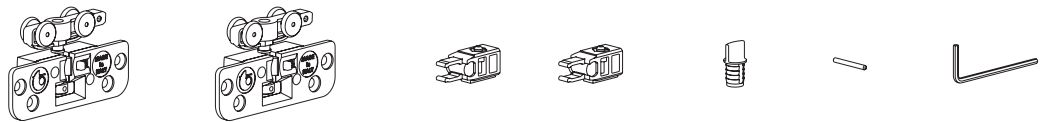

OLD CODE	NEW CODE	Weight	Quantity
2173/A	K.1251.1	15 kg	10x

MEASUREMENTS DESCRIPTION / DESCRIZIONE MISURE

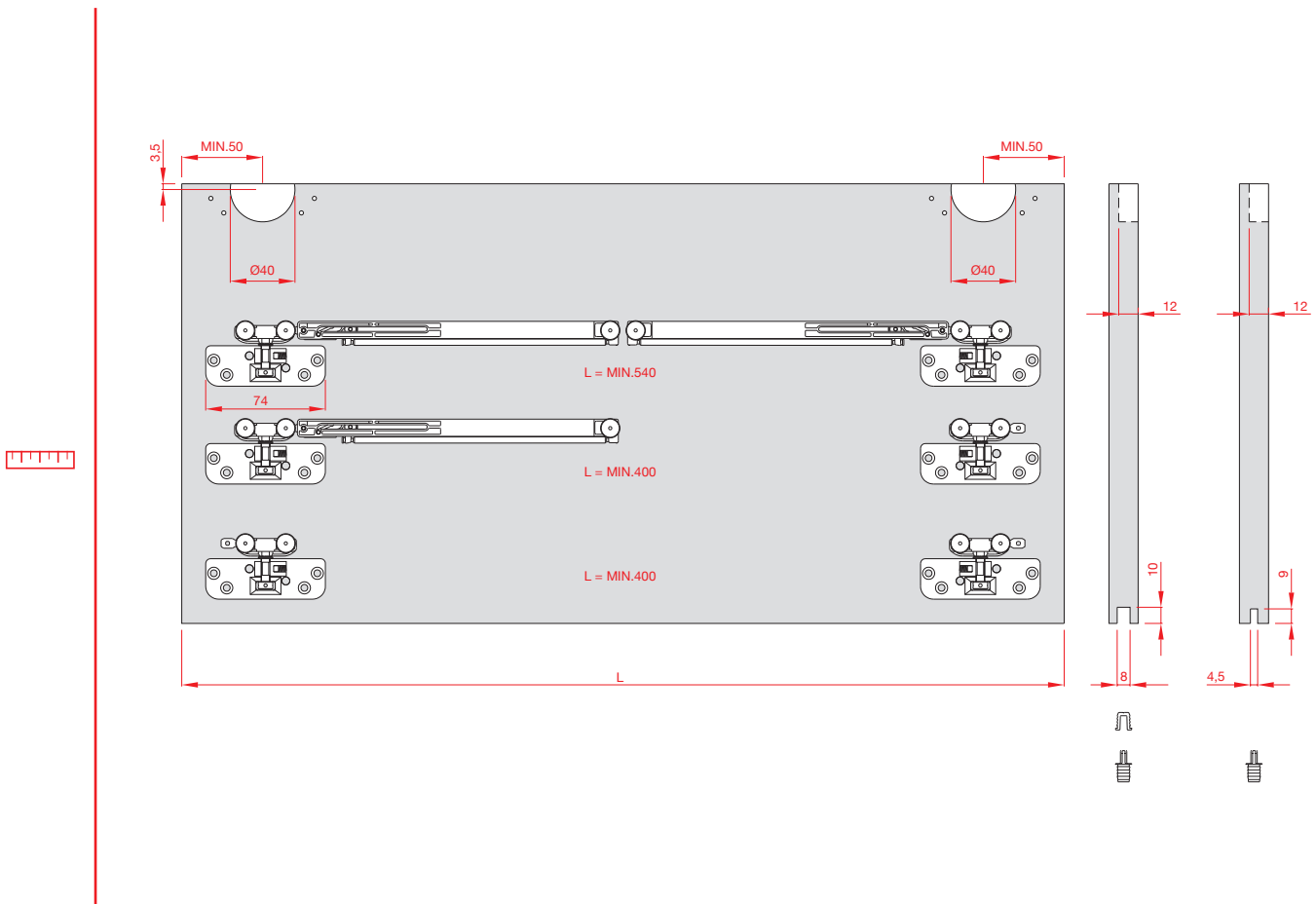

MEASUREMENTS DESCRIPTION / DESCRIZIONE MISURE

SP.18 → Z=9 X=24 W=4 Y=7
 SP.20 → Z=10 X=26 W=6 Y=9
 SP.22 → Z=11 X=28 W=8 Y=11

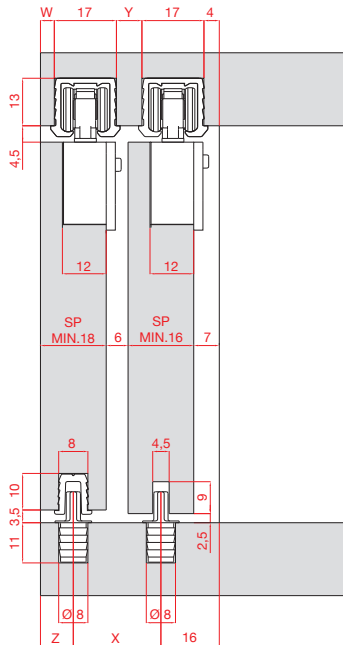

N.2 DOORS WITH SINGLE TRACK ART. 2175 / N.2 ANTE CON BINARIO SINGOLO ART. 2175

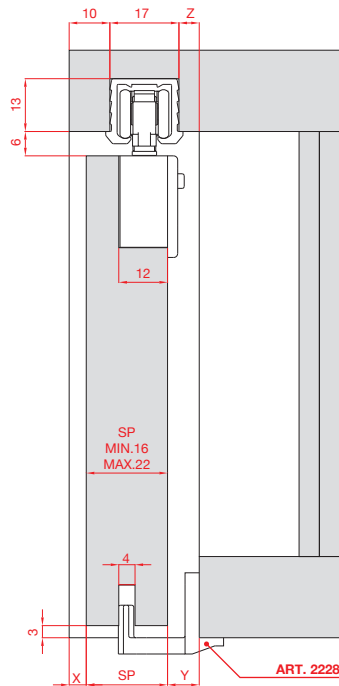

SP.16 → X=8 Y=10 Z=7
 SP.18 → X=6 Y=9 Z=6
 SP.20 → X=4 Y=8 Z=5
 SP.22 → X=2 Y=7 Z=4

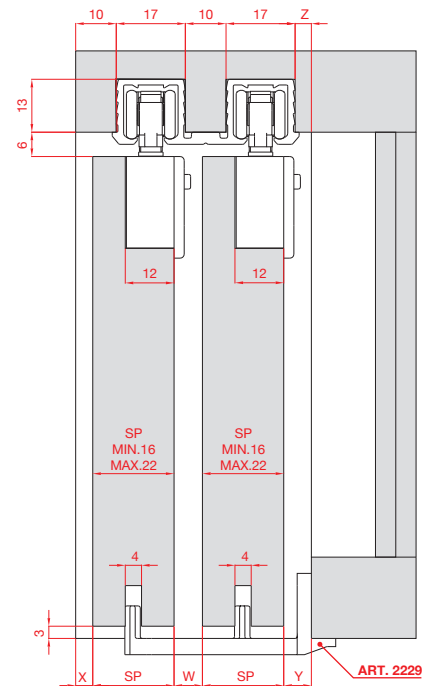

SP.16 → X=8 W=11 Y=9 Z=6
 SP.18 → X=6 W=9 Y=8 Z=5
 SP.20 → X=4 W=7 Y=7 Z=4
 SP.22 → X=2 W=5 Y=6 Z=3

OPTIONAL

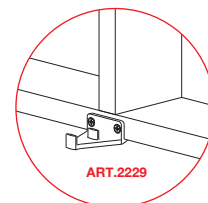
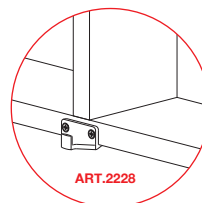
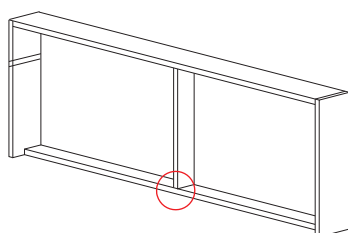

N.2 DOORS WITH DOUBLE TRACK ART. 2172 / N.2 ANTE CON BINARIO DOPPIO ART. 2172